

Data sheet | Item number: 722-234/005-000/039-000

Female connector for rail-mount terminal blocks; straight; 100% protected against mismatching; Locking lever; Pin spacing 5 mm; 4-pole

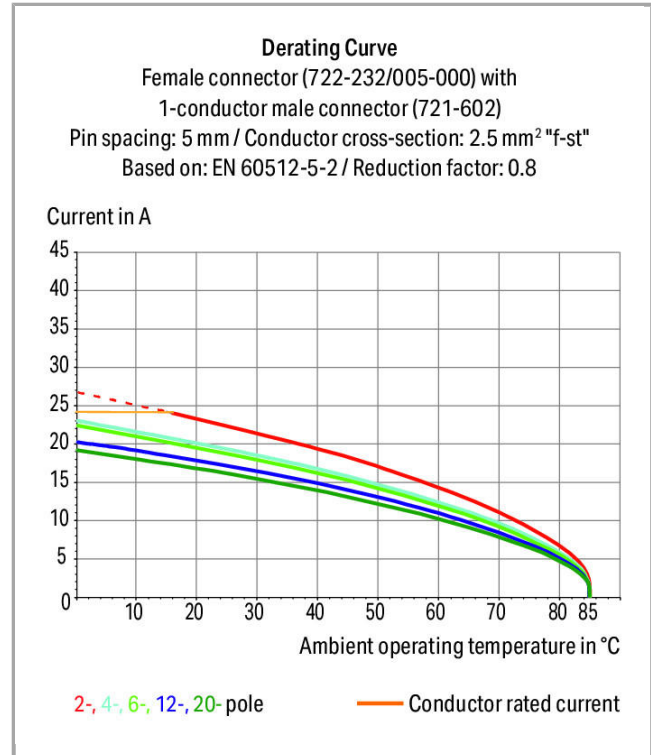

722-234/005-000/039-000

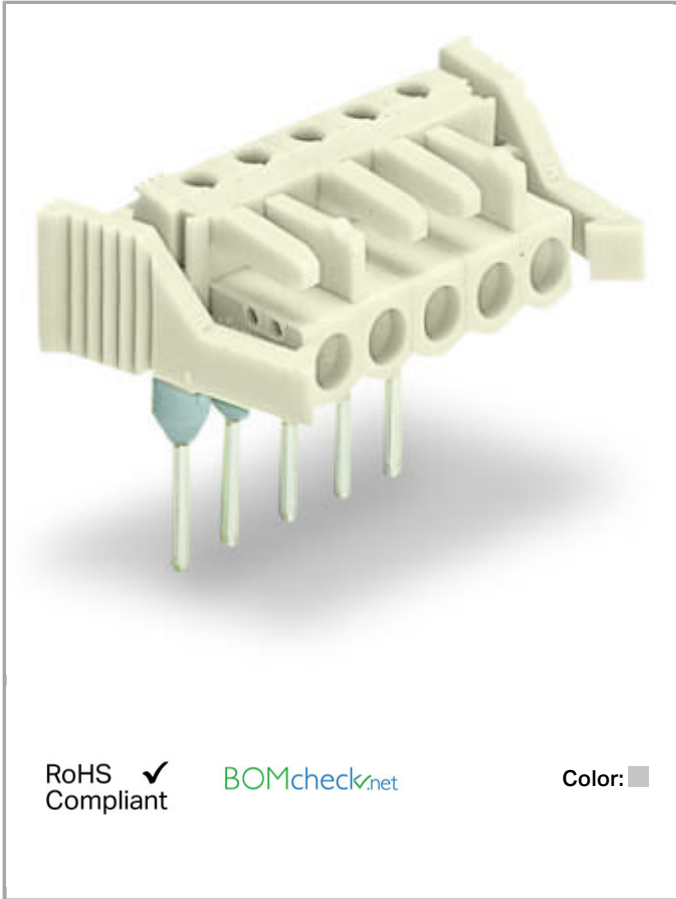

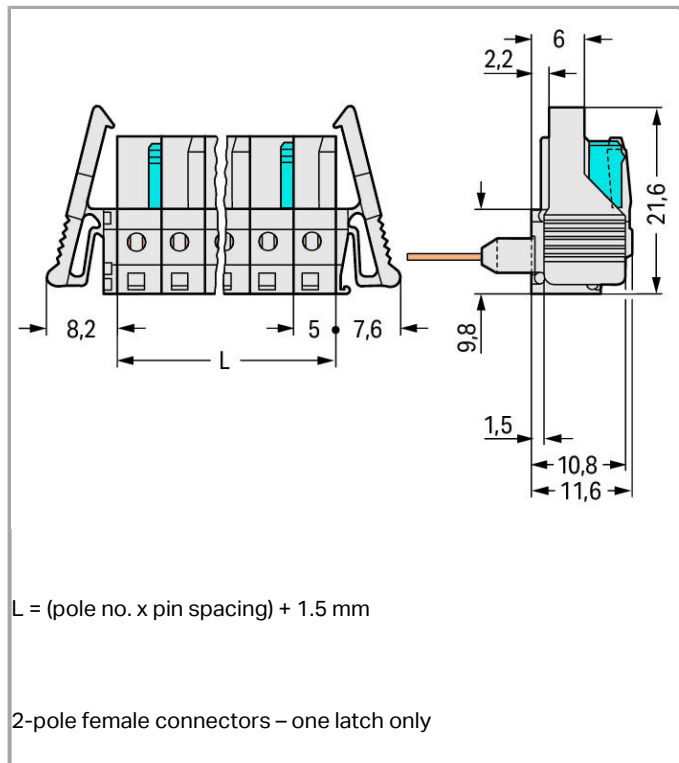

### Item description

- Pluggable connectors for rail-mount terminal blocks equipped with CAGE CLAMP® connection
- Female connectors with long contact pins connect to the termination ports of 280 Series Rail-Mount Terminal Blocks
- Female connectors are touch-proof when unmated, providing a pluggable, live output
- 100 % protected against mismatching
- With coding fingers

### Safety information 1:

The *MULTI CONNECTION SYSTEM (MCS)* is designed without breaking capacity for compliance with DIN EN 61984. When used as intended, MCS Connectors shall not be connected/disconnected when live or under load. The circuit design should ensure header pins, which can be touched, are not live when unmated.

### Data

#### Electrical data

#### Ratings per IEC/EN 60664-1

Rated voltage (III / 3)	320 V
Rated impulse voltage (III / 3)	4 kV
Rated voltage (III / 2)	320 V
Rated impulse voltage (III / 2)	4 kV
Rated voltage (II / 2)	630 V



Rated impulse voltage (II / 2)	4 kV
Rated current	12 A

### Approvals per UL 1059

Rated voltage UL (Use Group B)	300 V
Rated current UL (Use Group B)	15 A
Rated voltage UL (Use Group D)	300 V
Rated current UL (Use Group D)	10 A

### Approvals per UL 1977

Rated voltage per UL 1977 (factory wiring only)	600 V
Rated current per UL 1977 (factory wiring only)	15 A

### Approvals per CSA

Rated voltage CSA (Use Group B)	300 V
Rated current CSA (Use Group B)	15 A
Rated voltage CSA (Use Group D)	300 V
Rated current CSA (Use Group D)	10 A

### Connection data

No. of poles	4
Total number of potentials	4
Number of connection types	1
Number of levels	1

### Geometrical Data

Pin spacing	5 mm / 0.197 inch
Width	35.8 mm / 1.409 inch
Height	26.1 mm / 1.028 inch
Height from the surface	11.6 mm / 0.457 inch
Depth	18.25 mm / 0.719 inch

### Plug connection

Contact type (pluggable connector)	Female connector/socket
Connector connection type	for front-entry wiring terminal block
Mismating protection	Yes
Locking of plug-in connection	locking lever
Steckrichtung zur Reihenklemme	0°

## Material Data

Color	light gray
Material group	I
Insulating material	Polyamide 66 (PA 66)
Flammability class per UL94	V0
Contact material	Copper alloy
Contact plating	tin-plated
Fire load	0.099 MJ
Weight	5.35 g

## Environmental Requirements

Limit temperature range	-60 ... +85 °C
-------------------------	----------------

## Commercial data



Product Group	3 (Multi Conn. System)
Country of origin	DE
GTIN	4044918572453
Customs Tariff No.	85366990990

## Approvals / Certificates

### Country specific Approvals

Logo	Approval	Additional Approval Text	Certificate name
	CSA DEKRA Certification B.V.	C22.2	1466354

### UL-Approvals

Logo	Approval	Additional Approval Text	Certificate name
	UR UL International Germany GmbH	UL 1977	E45171
	UR UL International Germany GmbH	UL 1977	E45171

## Compatible products

## tools

	<b>Item no.: 280-434</b> Operating tool; of insulating material; 4-way	280-434
--	---	---------

## check

	<b>Item no.: 210-136</b> Test plug; 2 mm Ø; with 500 mm cable	210-136
--	--	---------

	<b>Item no.: 210-137</b> Test plug; 2.3 mm Ø; with 500 mm cable	210-137
--	--	---------

	<b>Item no.: 231-661</b> Test plugs for female connectors; for 5 mm and 5.08 mm pin spacing	231-661
--	--	---------

## General accessories

	<b>Item no.: 280-650/056-000</b> Spacer of same profile; suitable for 3-conductor terminal blocks of horizontal type	<a href="#">/056-000</a>	280-650
--	---	--------------------------	---------

	<b>Item no.: 280-654/056-000</b> Spacer of same profile; suitable for 3- and 4-conductor terminal blocks of angled type	<a href="#">/056-000</a>	280-654
--	--	--------------------------	---------

	<b>Item no.: 280-835/056-000</b> Spacer of same profile; suitable for 4-conductor terminal blocks of horizontal type	<a href="#">/056-000</a>	280-835
--	---	--------------------------	---------

	<b>Item no.: 280-902/056-000</b> Spacer of same profile; suitable for 2-conductor terminal blocks of horizontal type	<a href="#">/056-000</a>	280-902
--	---	--------------------------	---------

## Downloads

## CAD/CAE - Smart Data

## CAD data

3D Download 722-234/005-000/039-000	URL	Download
-------------------------------------	-----	----------

Subject to changes.